

32 Shank  
 (For the Palomar 2500/3500)

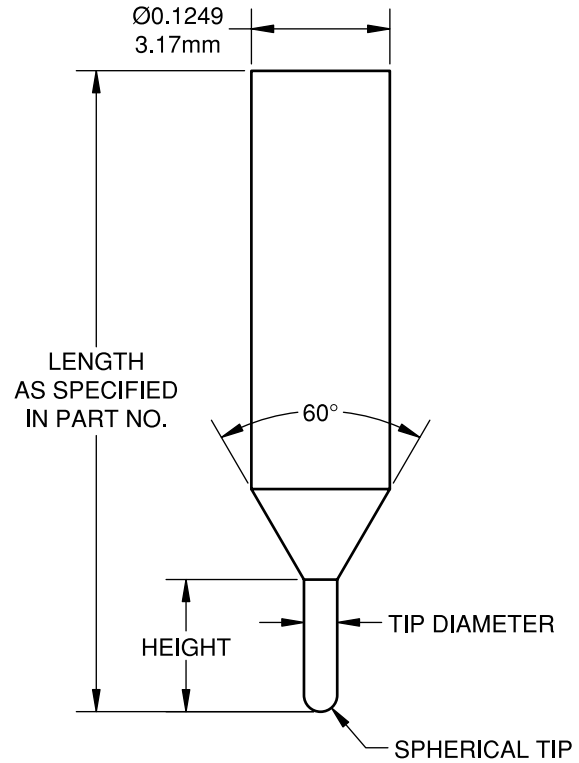

02 Shank  
 (Available to all shank styles)

**Specify:** Series/Shank Style - Tip Diameter - Height of Diameter - \*Shank Length - \*\*Material

**Example:**

3D32-030-120-SS

3D02-030-120-625-SS

\*Specify length for 01, 02, & 60 shanks only

\*\*Material is standard as Stainless Steel ("-SS")

Note: For tip diameters less than 0.010 in./0.25mm, the tip height should not exceed three times the tip diameter.

TYPICAL TIP CONFIGURATIONS	
TIP DIAMETER in./mm	HEIGHT in./mm
.005/0.13	.015/0.38
.010/0.25	.050/1.27
.015/0.38	.070/1.78
.020/0.51	.080/2.03
.025/0.64	.100/2.54
.030/0.76	.120/3.05
.035/0.89	.140/3.56
.040/1.02	.200/5.1
.045/1.14	
.050/1.27	
.055/1.40	
.060/1.52	
.065/1.65	
.070/1.78	
.075/1.90	
.080/2.03	

*Dimensions in inches unless otherwise specified*